

Lista Arlink® 7000 Adaptable Workbench Systems



Arlink 7000 Workbench Systems help companies like yours optimize performance in the workplace by providing efficient, ergonomic, and well-designed workbenches which significantly improve productivity, maximize use of floor space, boost morale and produce a safer work environment.

SUPERIOR VERSATILITY, SOLID VALUE

Arlink 7000 workbenches let you tailor your benches to your needs while providing greater versatility than conventional workbenches. Whether you chose stationary or mobile, or choose from our extensive selection of accessories, you can design a workbench that exactly suits your requirements.

Arlink 7000 workbenches' heavy-duty construction is capable of supporting 1000 lbs. (454 kg), evenly distributed. Durable worksurface choices include plastic laminate, static dissipative laminate and butcher block.

Workbench Combinations

Arlink® 7000 workbenches are available in seven sizes. Simply choose the base size, height and worksurface that best suits your needs, and add appropriate accessories, below-worksurface options and hanging drawers (see back cover). For other options and dimensions, please contact your Lista representative.

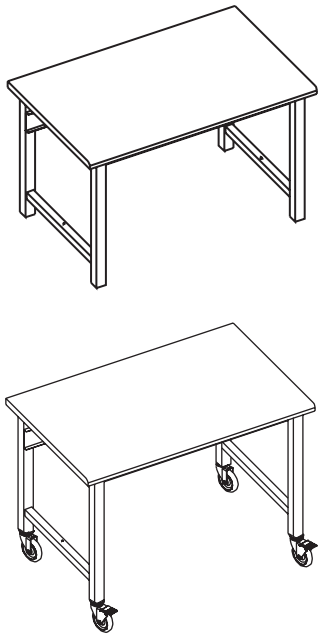

ARLINK 7000 SOLID VALUE WORKBENCH

Workbench height is 30" (76 cm) or 36" (91 cm). Heavy-duty 2" x 2" tubular legs include leveling glides. Load capacity for all benches is 1,000 lbs. (454 kg) evenly distributed.

STATIONARY WORKBENCH without leg extenders

l x d x h	No Worksurface	Standard Laminate	Static Dissipative	Butcher Block
48" x 30" x 30"	483030NT	483030SL	483030SD	483030BB
48" x 36" x 30"	483630NT	483630SL	483630SD	483630BB
60" x 30" x 30"	603030NT	603030SL	603030SD	603030BB
60" x 36" x 30"	603630NT	603630SL	603630SD	603630BB
72" x 30" x 30"	723030NT	723030SL	723030SD	723030BB
72" x 36" x 30"	723630NT	723630SL	723630SD	723630BB
48" x 30" x 36"	483036NT	483036SL	483036SD	483036BB
48" x 36" x 36"	483636NT	483636SL	483636SD	483636BB
60" x 30" x 36"	603036NT	603036SL	603036SD	603036BB
60" x 36" x 36"	603636NT	603636SL	603636SD	603636BB
72" x 30" x 36"	723036NT	723036SL	723036SD	723036BB
72" x 36" x 36"	723636NT	723636SL	723636SD	723636BB

LEG EXTENDERS*

Part No.

Set 7230LE

*allows nominal height adjustment of 6" on 2 increments

CASTER KIT*

Part No.

2-Swivel & 2-Swivel Locking, 5" Diam. 7M1000

*increases overall nominal height by 6"

Worksurfaces

Worksurfaces are chosen in conjunction with the workbench base, shown above.

STANDARD LAMINATE WORKSURFACE

Worksurface is constructed of 1 3/8" (3.5 cm) thick medium density particle board covered on top and all sides with dove gray, non-glare matte finish plastic laminate. The front edge is contoured for comfort and chip resistance. The under side of the worksurface is sealed with a plastic tension sheet to prevent moisture absorption, warping and shedding.

STATIC DISSIPATIVE LAMINATE WORKSURFACE

Worksurface is the same as the standard laminate worksurface, but with dove gray, non-glare matte finish plastic laminate that provides a controlled path to ground for the dissipation of static electricity. The worksurface is provided with a grounding kit that must be used to provide proper protection for components and personnel. Static dissipative value for the material is 10⁶ - 10⁹.

BUTCHER BLOCK WORKSURFACE

Worksurface is 1 3/4" (4.5 cm) thick satin finish hardwood with squared edge.

Stainless steel, phenolic resin and ball transfer worksurfaces are also available.

Below-Worksurface Options

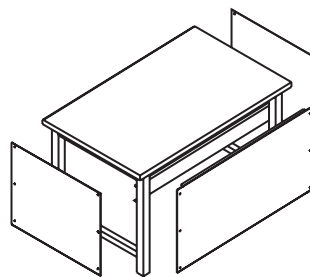

SKIRTING PANELS

Steel skirting panels enclose ends and back of bench.

END PANEL (workbench d x h)

Part No.

30" x 30" (76 x 76 cm)

3030EM

36" x 30" (91 x 76 cm)

3630EM

REAR PANEL (workbench l x h)

Part No.

48" x 30" (122 x 76 cm)

4830RM

60" x 30" (152 x 76 cm)

6030RM

72" x 30" (183 x 76 cm)

7230RM

Below-Worksurface Options (con't.)

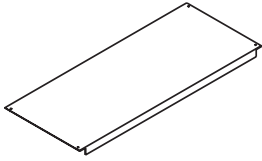

UNDER SHELF

For extra storage space under your benches, Arlink offers an 18" (46 cm) deep lower steel shelf which fastens to the leg braces.

Workbench Length

Part No.

48" (122 cm)	7Z4818US
60" (152 cm)	7Z6018US
72" (183 cm)	7Z7218US

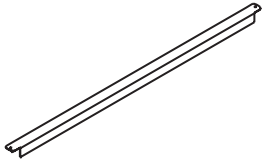

FIXED HEAVY GAUGE FOOTREST

Channel steel footrest mounts between horizontal leg ties.

Workbench Length

Part No.

48" (122 cm)	7E48FR
60" (152 cm)	7E60FR
72" (183 cm)	7E72FR

Above-Worksurface Options

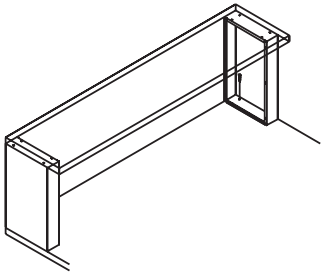

RISER SHELF WITH BOX SUPPORTS

14" (36 cm) deep shelves are finished in either standard laminate, static dissipative laminate or butcher block to match specified worksurface. Steel box supports are 19" (48 cm) high and 11" (28 cm) deep.

l x d x h

Standard Laminate*

Static Dissipative*

Butcher Block*

48" x 14" x 19" (122 x 36 x 48 cm)	481419SL	481419SD	481419BB
60" x 14" x 19" (152 x 36 x 48 cm)	601419SL	601419SD	601419BB
72" x 14" x 19" (183 x 36 x 48 cm)	721419SL	721419SD	721419BB

*Other materials available upon request.

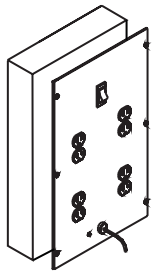

ELECTRICAL PANEL INSERT FOR BOX SUPPORT

The panel insert includes illuminated 15 Amp circuit breaker, 4 duplex receptacles and power cord. Electrical panels can be used on one or both shelf supports and can be purchased with shelf or added later.

Part No.

7Z19EP

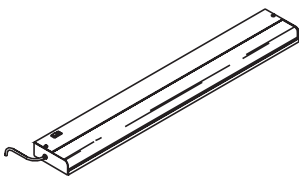

LIGHT FIXTURE FOR UNDER SHELF

Fastens to underside of riser shelf with wood screws. Includes acrylic diffuser, 7 1/2' power cord and rocker switch. Lights feature economical electronic ballasts and come complete with T8 fluorescent lamp.

Length

Part No.

36" (91 cm)	7Z36USL
48" (122 cm)	7Z48USL

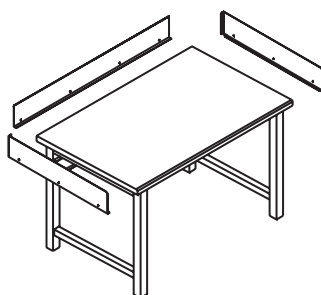

BACK AND END STOPS

Steel stops fasten to worksurface to provide back and end stops. Stops extend approx. 4" above workbench top. End stops are 30" deep and have rounded front corners. Back stop can also be attached to riser shelf.

l x h

Back Stop Only

Back and End Stops

48" x 4" (122 x 10 cm)	7J48BS	48BES
60" x 4" (152 x 10 cm)	7J60BS	60BES
72" x 4" (183 x 10 cm)	7J72BS	72BES

Hanging Drawers



HANGING DRAWER ASSEMBLY

16 3/4" wide

Steel drawer mounts under work-surface, and can slide to any hor-izontal position. Includes steel ball bearings, recessed handles and drawer stops. 100% full extension. Each unit comes with a lock and 2 keys.

Drawer	Worksurface Depth	Part No.
Single 5" Drawer	30" (76 cm)	7L1000
Single 5" Drawer	36" (91 cm)	7L1001
Single Shallow Drawer	30" (76 cm)	7L8000
Single Shallow Drawer	36" (91 cm)	7L8001
Two 5" Drawers	30" (76 cm)	7L5000
Two 5" Drawers	36" (91 cm)	7L5001
5" Box/File Drawer	30" (76 cm)	7L2000
5" Box/File Drawer	36" (91 cm)	7L2001
Three 5" Drawers	30" (76 cm)	7L3000
Three 5" Drawers	36" (91 cm)	7L3001

Vertical Space Integrator (VSI) System



VERTICAL SPACE INTEGRATOR SYSTEM

The VSI (Vertical Space Integrator) System is designed to expand the efficiency of any workbench, regardless of manu-facturer. With the VSI System, you're able to utilize the Arlink® 8000 system's wide range of accessory options (such as task lighting, storage shelves, power beams, parts bin rails, etc.) that easily attach to the vertical col-umn without the need for tools.

Upright Frame	Height	Part No.
Set VSI1	45"	7Z1016

Wire Shelves (l x h)	Depth	Part No.
30 x 12	12"	7Z1057
36 x 12	12"	7Z1058
48 x 12	12"	7Z1059
60 x 12	12"	7Z1060

Steel Shelves (length)	12" deep	15" deep
30"	7Z1167	7Z1172
36"	7Z1168	7Z1173
48"	7Z1169	7Z1174
60"	7Z1170	7Z1175

AVAILABLE COLORS

All items are available in Light Gray (LG) and Bright Blue (BB). Color must be specified at the time of order placement.

LISTA
making workspace work®

Lista International Ltd.
P.O. Box 1035
Burlington, ON Canada L7R 4L8
Tel: (905) 332-8484 1-888-559-4441
Fax: (905) 332-8277
E-mail: sales@listaintl.com
Web site: www.listaintl.com

ISO 9001

Prices and product specifications are subject to change without notice and are those in effect at time of order receipt.